



vietata la riproduzione a qualsiasi scopo. campione promozionale gratuito destinato alla vendita - Escluso IVA Art. 2 comma 3 D.P.R. 63/72 - Esportato da bolli di accompagnamento Art. 4 Punto 6 D.P.R. 62/78



ZONA NOTTE CABINE PIANCA 2011

ZONA NOTTE CABINE

CABINE ARMADIO, SISTEMI DI CHIUSURA, ATTREZZABILITÀ PIANCA 2011

PROGETTI DI CLASSE STUDIATI SU MISURA, RAFFINATA GAMMA DI MODELLI, MATERIALI PREGIATI, PROPORZIONI E GEOMETRIE ELEGANTI: LE CABINE ARMADIO PIANCA SI ACCORDANO CON IL CARATTERE DI OGNI CASA. *TAILOR-MADE CLASSY PROJECTS, A SOPHISTICATED COLLECTION OF CLOSETS REALIZED WITH PRECIOUS MATERIALS, BALANCED PROPORTIONS AND ELEGANT SHAPES: THE CLOSETS BY PIANCA ARE MADE TO MATCH THE STYLE OF EACH HOUSE*



FINITURE *Finishes*

NOBILITATI synthetic veneer



Bianco talco *Smooth off-white*



Grigio texture *Textured grey*

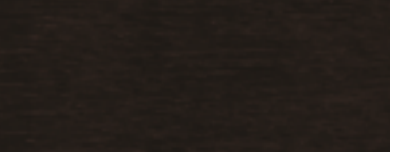

Rovere scuro



Noce canaletto

LACCATI OPACHI / LACCATI TEXTURE / LUCIDI SPAZZOLATI

Matt lacquered / Texture lacquered / High gloss lacquered



Bianco

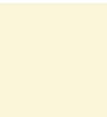

Avorio

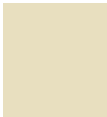

Corda



Tortora



Fango



Creta



Visone



Caffè

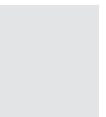

Nuvola



Grigio scuro



Lavagna



Nero



Mela



Salvia



Prato



Bosco



Sole



Mandarino



Ciliegia



Rubino



Rosa



Ciclamino



Violetto



Prugna



Polvere



Artico



Petrolio



Oltremare

VETRI NEUTRI neutral glass



Trasparente

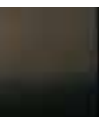

Fumè

VETRI OPACHI / LUCIDI Matt glass / High gloss glass

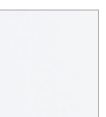

Bianco

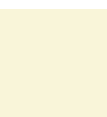

Avorio

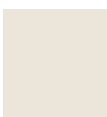

Tortora



Creta



Lavagna



Nero

CABINE ARMADIO

walk-in closets

Le cabine armadio di Pianca si accordano alla perfezione con il carattere di ogni casa. La raffinata gamma di modelli integra funzionalità e bellezza per un risultato finale di piacevole effetto. Materiali pregiati, proporzioni rassicuranti e geometrie eleganti sono gli elementi d'ispirazione che parlano il linguaggio del prodotto di valore. Progetti di classe, originali, studiati su misura che si lasciano ispirare dalla ricerca del comfort.

The closets by Pianca perfectly match the style of each house. The refined range of models integrates functionality and beauty for an aesthetically pleasing final result. Precious materials, reassuring proportions and elegant shapes are the inspiring elements that speak the language of the product's value. Classy and original projects that have been custom studied and inspired by the search for comfort.

INDICE

Index

Cabina armadio con mensole e fianchi al centimetro _LIBERA & SNAKE <i>Made-to-measure walk-in closets with shelves and sides</i> _Libera & Snake	007	
Cabine armadio a montanti in alluminio con cremagliera e sistemi di chiusura _ANTEPRIMA & VISTA <i>Upright aluminium closets with racks and door system</i> _Anteprima & Vista	031	
Accostamenti unici e versatili dei moduli armadio senza ante _SIPARIO <i>Unique and versatile matching of walk-in closet solutions</i> _Sipario	087	
Cabine armadio _SUGGERIMENTI COMPOSITIVI <i>Walk-in closets</i> _Suggested compositions	117	
Caratteristiche, dimensioni e finiture _INFORMAZIONI TECNICHE <i>Characteristics, dimensions and finishes</i> _Technical information	133	

LIBERA & SNAKE

Un modo nuovo di intendere la cabina armadio, una creatività che corre lungo fianchi e mensole al centimetro per creare spazi e forme giocose ma sempre funzionali. Sistemi di fissaggio a muro o su pannello, elementi disponibili nelle finiture melaminiche bianco, grigio texture, noce canaletto, rovere scuro o nella gamma dei laccati opachi texture. Cassettiere a terra, su ruote o sospese, a scelta fra le varie collezioni Pianca, completano la personalizzazione delle composizioni.

A new way of thinking about walk-in closets, creativity that runs through the panels and shelves made-to-measure to create functional yet playful spaces and shapes.

Wall-mounted or fixed on a panel, the items are available in these finishes: bianco, grigio texture, canaletto, rovere scuro or in the matt lacquered texture range. A chest of drawers on wheels or wall mounted, a choice between the various Pianca collections, complete customization of the compositions.

TUBI IN ACCIAIO
SPAZZOLATO, UNA
SCELTA DECISA
DA COMPORRE
LIBERAMENTE

*Brushed steel snake,
a firm choice to
compose freely*







Pagina 9: **Libera & Snake**__ cabina armadio fissata a muro L 400 x 292 H 224 P 51. Pedane in laccato opaco texture bianco, tubi in acciaio spazzolato.

People__ modulo appeso L 196 H 37 P 42 in laccato opaco bianco.

Geometrika__ specchiere rettangolari fissate a muro in posizione verticale.

Pagina 10: **Libera**__ cabina armadio fissata a muro L 400 x 470 H 240 P 51.1.

Ripiani, fianchi e pedane in laccato opaco texture bianco. Aste appendiabiti

bianco talco. **People**__ modulo appeso L 196 H 37 P 42 in laccato opaco

bianco. **Geometrika**__ specchiere rettangolari fissate a muro in posizione verticale.

Page 9: **Libera & Snake**__ wall-mounted closet W 400 x 292 H 224 D 51.

Texture bianco matt lacquered platforms, brushed steel snake.

People__ bianco matt lacquered wall-mounted drawer unit W 196 H 37 D 42.

Geometrika__ wall-mounted rectangular mirrors in vertical position.

Page 10: **Libera**__ wall-mounted closet W 400 x 470 H 240 D 51.1.

Shelves, sides and platforms in texture bianco matt lacquered.

Off-white hanging rods. **People**__ bianco matt lacquered wall-mounted drawer

unit W 196 H 37 D 42. **Geometrika**__ wall-mounted rectangular mirrors

in vertical position.

LA PARTICOLARE
FINITURA TEXTURE
TROVA RISALTO
IN TUTTI I COLORI
LACCATI OPACHI

*The particular texture finish
becomes precious when combined
with the matt lacquered colors*







Pagina 16: **Libera**__ cabina armadio fissata su schienali L 471 H 270 P 57.2. Schienali in laccato opaco grigio scuro, ripiani e fianchi in laccato opaco texture grigio scuro. Aste appendiabiti in titanio. **Segno**__ comodini L 131 H 25 P 54 in poro aperto laccato opaco grigio scuro. **Geometrika**__ specchiere rettangolari fissate a muro in posizione verticale.

Page16: **Libera**__ closet fixed on back panels W 471 H 270 D 57.2. Back panels in grigio scuro matt lacquered, shelves and sides in texture grigio scuro matt lacquered. Titanium hanging rods. **Segno**__ drawer units in open pore grigio scuro matt lacquer W 131 H 25 D 54. **Geometrika**__ wall-mounted rectangular mirrors in vertical position.

LIBERA & SNAKE

attrezzabilità / *examples of possible configurations*

Alla grande libertà di personalizzazione della cabina Libera, per quanto concerne la scelta di finiture ed elementi, si aggiunge la sua totale flessibilità compositiva. Grazie alla progettazione al centimetro, sia in larghezza che in altezza, di fianchi e mensole, si scopre un'infinita e inaspettata varietà di soluzioni adatte al proprio spazio d'arredo.

Libera combines a wide choice of finishes to the total flexibility offered by the possibility to customize the closets to meet the most different needs. Shelves and sides can be customized in height and width.

UN ORDINATO
INTRECCIO DI
LINEE E STILI PER
DISEGNARE LA
FUNZIONALITÀ

*A weaving of lines and
style, combining design
and functionality*





sinistra: Modulo appeso People.
centro: Asta appendiabiti verniciata bianco talco.
destra: Ripiani e fianchi in laccato opaco texture grigio scuro.

*left: Wall-mounted People drawer unit.
centre: Hanging rods in off-white.
right: Shelves and sides in texture grigio scuro matt lacquered.*



Pagina a lato: **Libera & Snake**__ tubi a muro in acciaio spazzolato.

Opposite page: **Libera & Snake**__ Wall mounted snake in brushed steel.

Cabine armadio **ATTREZZABILITÀ** 029

ANTEPRIMA & VISTA

Totale libertà compositiva per le cabine armadio Anteprima a montanti in alluminio con cremagliera. Sistemi dotati di ripiani modulari spostabili, cassettiere, numerosi accessori, luci a led, strutture rifinibili con o senza schienali, per lasciare spazio alle soluzioni più esigenti ed esclusive. Il sistema di chiusura Vista si caratterizza per la totale assenza di telai o per il sottile profilo perimetrale e modularità al centimetro, per dividere ed unire gli spazi allo stesso tempo.

Total freedom in the composition for the upright aluminium Anteprima closets with rack. Systems equipped with movable modular shelves, drawer units, a wide range of accessories, led lights and paintable structures with or without back panels, to satisfy even the most demanding and unusual requests. The door system Vista is characterized by the absence of frames or by the thin profile. It is made-to-measure to divide and unite the spaces at the same time.

ANTE LISCE
SENZA TELAIO
DAL RISULTATO
VISIVO CONTINUO
E SENZA LIMITI

*Smooth, frameless doors
that give a continuous and
unlimited visual result*







Pagina 33: **Vista**__ sistema di chiusura con pannello fisso e quattro ante Plana L 100 H 257.7 in laccato opaco bianco e maniglia U40 in laccato opaco bianco, binario di scorrimento in alluminio per cartongesso.

Page 33: **Vista**__ door system with a fixed panel and four bianco matt lacquered Plana doors W 100 H 257.7 and bianco matt lacquered U40 handle, rail in aluminium for dry wall.

PARTICOLARI
VERNICIATI BIANCHI
PER UN AFFASCINANTE
TOCCO DI MORBIDEZZA
DELLA STRUTTURA

*White painted details give
the structure a charming
touch of softness*







Pagina 40: **Anteprima**__ cabina armadio con schienali L 461.7 H 257.7 P 58.2. Schienali, ripiani con staffe a scomparsa, pedane e cassettiere con frontale legno in nobilitato bianco talco. Aste appendiabiti e staffe verniciate bianco talco.

Pagina a lato: **Anteprima**__ cabina armadio nella versione senza schienali, con montanti a cremagliera in alluminio anodizzato.

Page 40: **Anteprima**__ closet with back panels W 461.7 H 257.7 D 58.2. Back panels, shelves with invisible brackets, platforms and drawer units with smooth off-white front. Off-white hanging rods and brackets. Opposite page: **Anteprima**__ closet without back panels, with anodized aluminium rack uprights.

VETRI TRASPARENTI
PER UN AUTENTICO
SEGNO DI LEGGEREZZA

*Clear glass for an
ambience of levity*







Pagina 46: **Vista**__ sistema di chiusura con quattro ante Crystal L 100 H 257.7 in vetro trasparente ed apertura con gola, binario di scorrimento in alluminio per cartongesso.

Page 46: **Vista**__ door system with four Crystal doors W 100 H 257.7 in clear glass and groove opening, rail in aluminium for dry wall.





Pagina 50: **Anteprima**__ cabina armadio con schienali legno e specchio argento L 516 x 285.7 H 257.7 P 58.2. Schienali, ripiani con staffe a scomparsa, pedane in laccato opaco texture tortora, cassettiere con frontale vetro lucido tortora. Aste appendiabiti e staffe titanio.
Pagina a lato: **Anteprima**__ dettaglio dello schienale in laccato opaco texture.

*Page 50: **Anteprima**__ closet with wooden back panels and silver mirror, W 516 x 285.7 H 257.7 D 58.2. Back panels, shelves with invisible brackets, texture tortora matt lacquered platforms, drawer units with tortora glossy glass fronts. Titanium hanging rods and brackets.
Opposite page: **Anteprima**__ detail of the texture matt lacquered back panel.*

STILE DECISO ED
ORIGINALE GRAZIE
AI VETRI LUCIDI
LAVAGNA

*Confidence and originality
from the lavagna
lacquered glossy glass*







Pagina 56: **Vista**__ sistema di chiusura con tre ante Profilo L 120 H 238.5 in vetro lucido lavagna, maniglia U40 e profilo brill, binario di scorrimento in alluminio pitturabile.

*Pagina 56: **Vista**__ door system with three lavagna glossy glass Profilo doors W 120 H 238.5, brill profile and U40 handle, rail in paintable aluminium.*





Pagina 60: **Anteprima**__ cabina armadio con schienali legno e specchio argento L 371.6 x 333.5 H 257.7 P 58.2. Schienali, ripiani con staffe a vista, pedane e raster in nobilitato grigio texture, cassettiere con frontale vetro lucido lavagna. Aste appendiabiti e staffe titanio.

Pagina a lato: **Anteprima**__ cabina armadio nella versione senza schienali, con montanti a cremagliera in alluminio pitturabile.

Pagina 60: **Anteprima**__ closet with wooden back panels and silver mirror, W 371.6 x 333.5 H 257.7 D 58.2. Back panels, shelves with visible brackets, grigio texture platforms and cubbies, drawers unit with lavagna glossy glass fronts. Titanium hanging rods and brackets.

Opposite page: **Anteprima**__ closet in the version without back panels, with paintable aluminium rack uprights.

EFFETTO
INCONFONDIBILE
DELLE MANIGLIE
BRUNITE CHE SI
RISPECCHIANO SUI
VETRI FUMÉ

*The unmistakable effect
of burnished handles
reflected on fumé glass*







Pagina 66: **Vista**__ sistema di chiusura con quattro ante Profilo L 100 H 238.5 in vetro fumè, maniglia U40 e profili brunito, binario di scorrimento in alluminio pitturabile.

*Page 66: **Vista**__ door system with four fumé glass Profilo doors W 100 H 238.5, burnished profile and U40 handle, rail in paintable aluminium.*





Pagina 70: **Anteprima**__ cabina armadio con schienali legno e vetro retroilluminato L 285.7 x 380 H 257.7 P 58.2. Schienali, ripiani con staffe a scomparsa, pedane e cassettiere con frontale legno in nobilitato noce canaletto. Aste appendiabiti e staffe titanio.

*Page 70: **Anteprima**__ closet with wooden and backlit glass back panels, W 285.7 x 380 H 257.7 D 58.2. Back panels, shelves with invisible brackets, platforms and drawer units with canaletto wooden fronts. Titanium hanging rods and brackets.*

ANTEPRIMA

attrezzabilità / *examples of possible configurations*

Progettate con cura e dedizione, le attrezzature interne consentono una disposizione ordinata dei capi di abbigliamento con grande eleganza di presentazione. Svariati gli accessori e le loro combinazioni, simbolo di praticità e qualità.

Designed with care and dedication, the internal fittings allow for an orderly arrangement of clothes with great elegance of presentation. All the various accessories can be mixed and matched, a symbol of practicality and quality.

INFINITE
CONFIGURAZIONI
DEGLI INTERNI CABINA,
CARATTERIZZABILI
NEL SEGNO DEL GUSTO
E DELLO STILE

*Endless internal closet
possibilities, characterized
by taste and style*





Esempio compositivo di attrezzatura interna nella finitura grigio texture. Schienali in legno, in vetro retroilluminato o specchio. Cassettiere nella versione sottopiano o pensile, con frontali in legno o in vetro lucido lavagna. Aste appendiabiti e staffe titanio.

Example of internal fitting combination in grigio texture finish. Wooden, backlit glass or mirror back panels; under-shelf or wall-mounted drawer units, with wooden or lavagna glossy glass fronts. Titanium hanging rods and brackets.

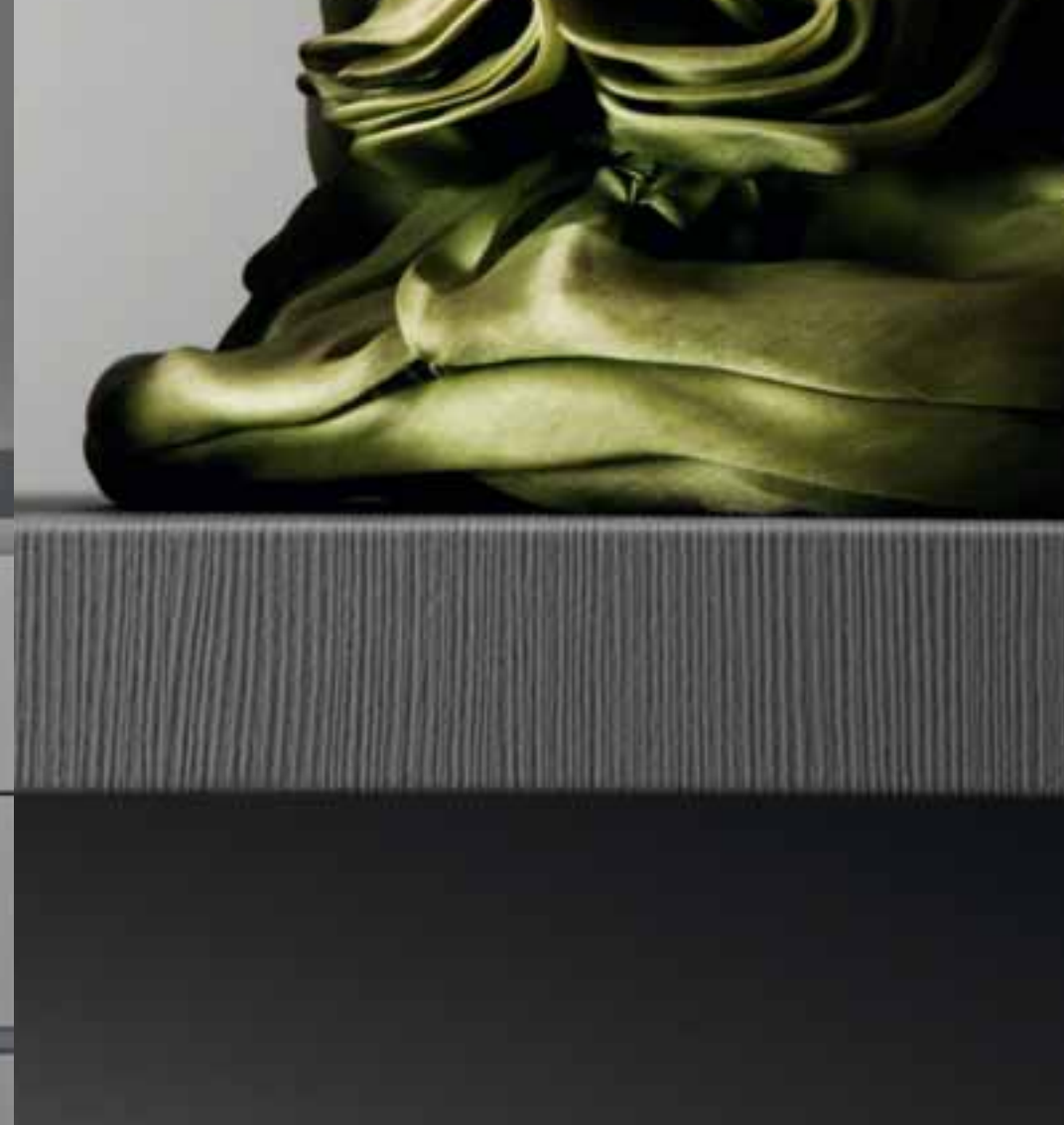

sinistra: Cassetto con telaio metallico estraibile con portapantaloni.
centro: Cassettiera con frontali legno in nobilitato grigio texture.
destra: Dettaglio del ripiano con nobilitazione avvolta grigio texture.

*left: Drawer unit with pull-out metal frame with a trouser rack.
centre: Drawer unit with grigio texture fronts.
right: Detail of the grigio texture shelf with "wrapped" technique.*



sinistra: Dettaglio della cabina attrezzata con ripiani con staffe a scomparsa.
destra: Dettaglio della cabina attrezzata con ripiani con staffe a vista.

*left: Detail of the closet equipped with shelves with invisible brackets.
right: Detail of the closet equipped with shelves with visible brackets.*



Pagina a lato: **Anteprima**__ dettaglio dei raster pensili.

Opposite page: **Anteprima**__ detail of suspended cubbies.

Cabine armadio **ATTREZZABILITÀ** 085

SIPARIO

Accostamenti unici e versatili dei moduli armadio senza ante, espressione della comodità del vivere quotidiano libero e dinamico. Prestigiose ed accurate le possibili finiture estetiche del telaio. Vani attrezzabili con numerosi accessori anche estraibili, per un'estrema facilità d'uso.

Unique and versatile combinations of modular walk-in closets; an expression of a free and dynamic lifestyle. The various types of aesthetic finishes of the frame are prestigious and elegant. Compartments equipped with a wide range of pull-out accessories allow for ease of use.

AMPI E RIGOROSI
SPESSORI PER UNA
CABINA ARMADIO
DISTINGUIBILE
SEMPRE

*Extensive and rigorous
thicknesses for a unique closet*







Pagina 90: **Sipario**__ cabina armadio L 480 H 257.7 P 60.4 con moduli a giorno e telai perimetrali in nobilitato bianco talco. Cassettiera con frontali vetro lucido bianco. Aste appendiabiti verniciate bianco talco.

*Pagina 90: **Sipario**__ closet W 480 H 257.7 D 60.4 with open modules and smooth off-white frames. Drawer unit with bianco glossy glass fronts. Off-white painted hanging rods.*

ATMOSFERA CALDA
E PREGIATA EVOCATA
DALL'ESSENZA
DEL LEGNO NOCE

*A warm and precious
atmosphere evoked
by the canaletto finish*







Pagina 96: **Sipario**__ cabina armadio L 370 + 370 H 257.7 P 60.4 con moduli a giorno e telai perimetrali in nobilitato noce canaletto. Raster e cassettiere con frontali legno in nobilitato noce canaletto. Aste appendiabiti cromo.
Pagina a lato: **Sipario**__ dettaglio del raster sospeso con bordi in nobilitato avvolto noce canaletto.

Page 96: **Sipario**__ closet W 370 + 370 H 257.7 D 60.4 with open modules and canaletto frames. Cubbies and drawer units with canaletto wooden fronts. Chrome hanging rods.

Opposite page: **Sipario**__ detail of the wall-mounted cubby with edges in "wrapped" canaletto finish.

COMPOSIZIONI UNICHE,
ESPRESSIONI DI UN
VIVERE QUOTIDIANO
LIBERO E DINAMICO

*Unique compositions,
expressions of a free and
dynamic lifestyle*







Pagina 102: **Sipario**__ cabina armadio L 463.6 x 316.8 H 257.7 P 60.4 con moduli a giorno e telai perimetrali in nobilitato noce canaletto. Raster e cassettiere con frontali legno in nobilitato noce canaletto e vetro lucido bianco. Aste appendiabiti cromo.

Pagina a lato: **Sipario**__ dettaglio del cassetto con telaio metallo e sacche portabiancheria.

Page 102: **Sipario**__ closet W 463.6 x 316.8 H 257.7 D 60.4 with open modules and canaletto frames. Cubbies and drawer units with canaletto wooden fronts or with white glossy glass fronts. Chrome hanging rods. Opposite page: **Sipario**__ detail of the drawer unit with metal support and laundry bags.

SIPARIO

attrezzabilità / *examples of possible configurations*

Ampio assortimento delle attrezzature interne, estremamente eclettiche ed esteticamente raffinate, per tante combinazioni su misura pratiche e ricercate.

Abbinamenti piacevoli dei numerosi accessori che esprimono contemporaneità e stile.

A wide range of internal accessories are combined and tailored to the user's needs to provide an aesthetically refined and practical solution.

The elegant combinations evoke an expression of modernity and style.

OGGETTI DI FINE
ESECUZIONE DAL
GRANDE VALORE
FUNZIONALE

*Exquisite products with
a great functional value*





Esempio compositivo di attrezzatura interna nella finitura bianco talco.
Cassettiere nella versione a terra o sospesa, con frontali in legno o in vetro lucido bianco.
Aste appendiabiti verniciate bianco talco.

*Example of internal fittings in the smooth off-white finish.
Floor sitting or hanging drawer units, with wooden or glossy white glass fronts.
Off-white painted hanging rods.*



sinistra: Cassettiera sospesa con telaio in metallo e portascarpe.
centro: Cassettiera con frontali in vetro lucido bianco.
destra: Telaio metallico estraibile con portapantaloni.

*left: Hanging drawer unit with metal frame and shoe rack.
center: Drawer unit with white glossy glass fronts.
right: Pull-out metal frame with trouser rack.*



Pagina a lato: scatole componibili con coperchio
o suddivise da pratici vani.

*Opposite page: modular boxes can be closed with lids
or used as into practical compartments.*

SUGGERIMENTI COMPOSITIVI

Un ricco programma per arredare, creare ed interpretare l'ambiente secondo le tendenze progettuali del momento. Elementi strutturali eclettici che si modulano a seconda delle necessità e che si rispecchiano in composizioni fresche e vivaci. Un tocco di stile inconfondibile.

An exhaustive range to furnish, create and interpret your space according to the latest design trends. Eclectic structural modules that can be combined according to individual needs while creating fresh and bright compositions. A touch of unmistakable style.

LIBERA & SNAKE

Un modo nuovo di intendere la cabina armadio, una creatività che corre lungo fianchi e mensole al centimetro per creare spazi e forme giucose ma sempre funzionali. Sistemi di fissaggio a muro o su pannello, elementi disponibili nelle finiture melamminiche bianco, grigio texture, noce canaletto, rovere scuro o nella gamma dei laccati opachi texture. Cassettiere a terra, su ruote o sospese, a scelta fra le varie collezioni Pianca, completano la personalizzazione delle composizioni.

A new way of thinking about walk-in closets, a creativity that runs through the panels and shelves made-to-measure to create playful spaces and shapes functional yet. Wall-mounted fixed or on a panel, the items are available in these finishes: bianco, grigio texture, canaletto, rovere scuro or in the matt lacquered texture range. A chest of drawers on wheels or wall mounted, complete a choice between the various Pianca collections, complete customization of the compositions.



Libera__ cabina armadio fissata a muro L 457 H 220 P 53. Ripiani e fianchi in nobilitato bianco talco. Aste appendiabiti verniciate bianco talco.
Anteprima__ cassettiere in appoggio su pedana nobilitato bianco talco.

Libera__ wall-mounted closet W 457 H 220 D 53.

Smooth off-white shelves and sides. Off-white painted hanging rods.

Anteprima__ smooth off-white platform and stacked drawer unit.



Libera__ cabina armadio fissata a muro L 261 x 327 H 220 P 52.
 Ripiani e fianchi in laccato opaco oltremare, aste appendiabiti in titanio.
People__ moduli a terra e sovrapposti L 261 e 196 H 25 P 52 in laccato opaco oltremare.
Geometrika__ specchiere trapezoidali fissate a muro.

Libera__ wall-mounted closet W 261x 327 H 220 D 52. Shelves and sides in texture oltremare matt lacquered, titanium hanging rods.
People__ matt lacquered oltremare stacked drawer units W 261 and 196 H 25 D 52.
Geometrika__ wall-mounted trapezoidal mirrors.

cabine armadio **LIBERA_L04** 120



Libera & Snake__ cabina armadio fissata a muro L 392 H 198 P 65.
 Tubi in acciaio spazzolato. **People**__ pedana e moduli appesi L 131 H 37 P 42 in laccato opaco grigio scuro.

Libera & Snake__ wall-mounted closet W 392 H 198 D 65.
 Brushed steel snake. **People**__ grigio scuro matt lacquered platform and wall-mounted drawer units W 131 H 37 D 42.

ANTEPRIMA

Totale libertà compositiva per le cabine armadio Anteprima a montanti in alluminio con cremagliera. Sistemi dotati di ripiani modulari spostabili, cassettiere, numerosi accessori, luci a led, strutture rifinibili con o senza schienali, per lasciare spazio alle soluzioni più esigenti ed esclusive. Il sistema di chiusura Vista si caratterizza per la totale assenza di telai o per il sottile profilo perimetrale e modularità al centimetro, per dividere ed unire gli spazi allo stesso tempo.

Total freedom in the composition for the upright aluminium Anteprima closets with rack. Systems equipped with movable modular shelves, drawer units, a wide range of accessories, led lights and paintable structures with or without back panels, to satisfy even the most demanding and unusual requests. The door system Vista is characterized by the absence of frames or by the thin perimetrical profile and modular nature, made-to-measure to divide and unite the spaces at the same time.



Anteprima__ cabina armadio con schienali L 371.6 H 289.7
P 56.2/58.2 per ogni lato. Ripiani con staffe a scomparsa, pedane e
cassettiere con frontale legno in nobilitato bianco talco.
Aste appendiabiti e staffe bianco talco.

Anteprima__ closet with back panels W 371.6 H 289.7
D 56.2/58.2 each side. Shelves with invisible brackets, platforms and
drawer units with smooth off-white front.
Off-white painted hanging rods and brackets.

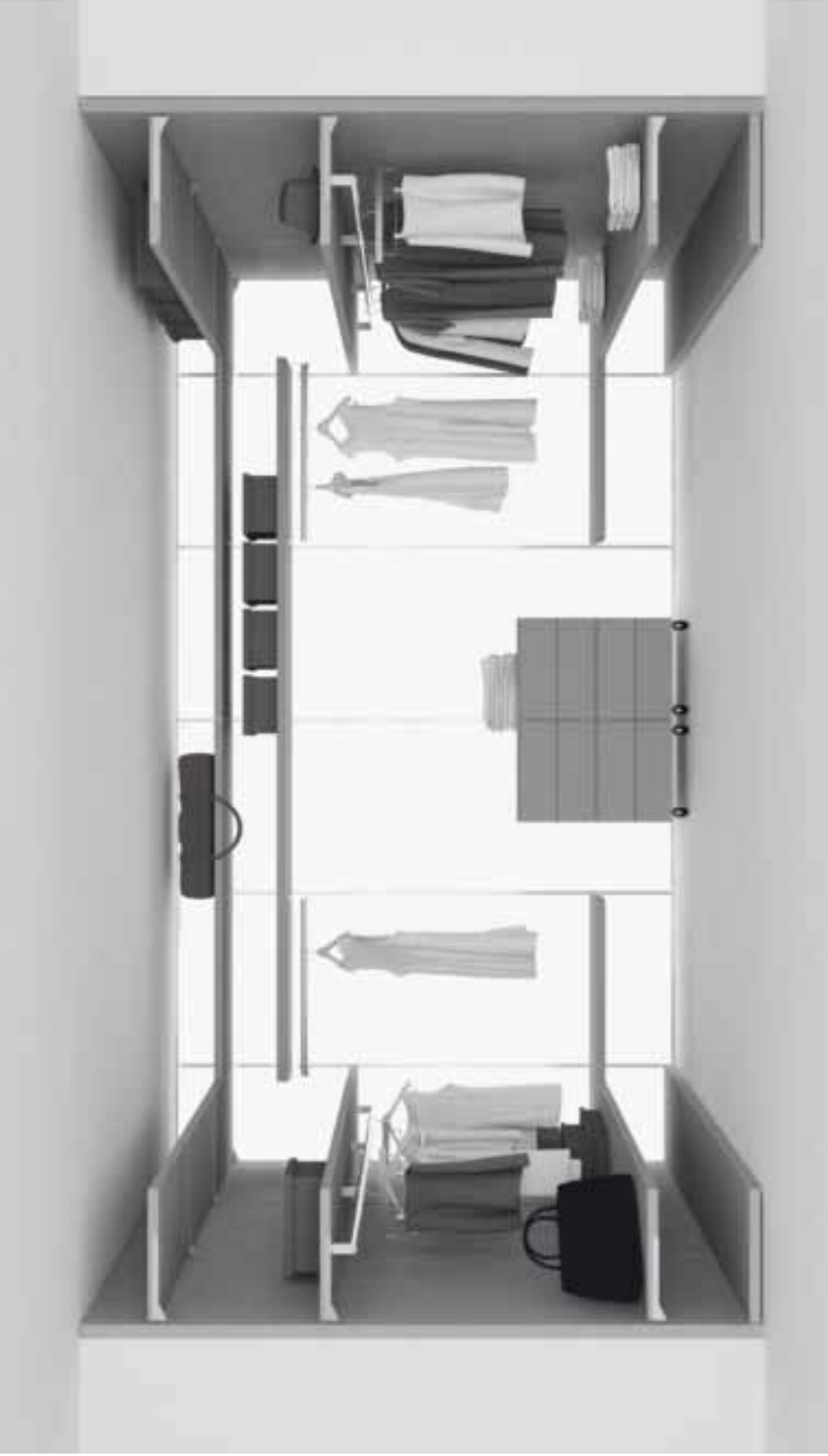

Anteprima__ cabina armadio con schienali legno e vetro retroilluminato L 281.5 x 475.6 H 257.7 P 58.2. Schienali, ripiani con staffe a vista, pedane e cassetteiere con frontale legno in nobilitato grigio texture. Aste appendiabiti e staffe titanio.

Anteprima__ closet with wooden and backlit glass back panels W 281.5 x 475.6 H 257.7 D 58.2. Back panels, shelves with visible brackets, platforms and drawer units with grigio texture fronts. Titanium hanging rods and brackets.

cabine armadio **ANTEPRIMA_A06** 124



Anteprima__ cabina armadio senza schienali L 279.4 x 380.6 H 257.7 P 56.3, con montanti a cremagliera in alluminio anodizzato. Ripiani con staffe a scomparsa, pedane e cassetteiere con frontale legno in laccato opaco texture grigio scuro e bianco. Aste appendiabiti e staffe titanio.

Anteprima__ closet without back panels W 279.4 x 380.6 H 257.7 D 56.3, with anodized aluminium rack uprights. Shelves with invisible brackets, platforms and drawer units with grigio scuro and bianco texture matt lacquered front. Titanium hanging rods and brackets.

cabine armadio **ANTEPRIMA_A07** 125



Anteprima__ cabina armadio con schienali legno e specchio argento L 461.7 H 289.7 P 58.2. Schienali, ripiani con staffe a scomparsa, pedane in nobilitato noce canaletto e cassettiere con frontale legno in nobilitato bianco talco. Aste appendiabiti e staffe titanio.

Anteprima__ closet with wooden back panels and silver mirror W 461.7 H 289.7 P 58.2. Back panels, shelves with invisible brackets, canaletto platforms and drawer units with smooth off-white fronts. Titanium hanging rods and brackets.

cabine armadio **ANTEPRIMA_A08** 126



Anteprima__ cabina armadio senza schienali L 279.4 x 330.5 H 257.7 P 56.3 con montanti a cremagliera in alluminio anodizzato. Ripiani con staffe a scomparsa, pedane e cassettiere con frontale legno in nobilitato rovere scuro. Aste appendiabiti e staffe titanio.

Anteprima__ closet without panels W 279.4 x 330.5 H 257.7 D 56.3, with anodized aluminium rack uprights. Shelves with invisible brackets, platforms and drawer units with rovere scuro wooden fronts. Titanium hanging rods and brackets.

cabine armadio **ANTEPRIMA_A09** 127

SIPARIO

Accostamenti unici e versatili dei moduli armadio senza ante, espressione della comodità del vivere quotidiano libero e dinamico. Prestigiose ed accurate le possibili finiture estetiche del telaio. Vani attrezzabili con numerosi accessori anche estraibili, per un'estrema facilità d'uso.

Unique and versatile combinations of modular walk-in closets; an expression of a free and dynamic lifestyle. The various types of aesthetic finishes of the frame are prestigious and elegant. Compartments equipped with a wide range of pull-out accessories, allow for ease of use.



Sipario — cabina armadio L 116.8 x 356.8 H 257.7 P 60.4 con moduli a giorno e telai perimetrali in nobilitato grigio texture. Cassettiera con frontali legno in nobilitato grigio texture. Aste appendiabiti cromo.
Tratto — armadio scorrevole a due ante in laccato lucido nuvola L 243.8 H 257.7.

Sipario — closet W 116.8 x 356.8 H 257.7 D 60.4 with open modules and grigio texture frames. Drawer unit with fronts in grigio texture. Chrome hanging rods.

Tratto — wardrobe with two sliding doors in nuvola high gloss lacquered finish, W 243.8 H 257.7.



Sipario — cabina armadio L 310 + 310 H 257.7 P 60.4 con moduli a giorno e telai perimetrali in nobilitato bianco talco. Ripiani e cassettiere con frontali legno in laccato opaco texture petrolio. Aste appendiabiti verniciate bianco talco.

Sipario — closet W 310 + 310 H 257.7 D 60.4 with open modules and smooth off-white frames. Shelves and drawer units with petrolio texture matt lacquered fronts. Off-white painted hanging rods.

cabine armadio **SIPARIO_S05** 130



Sipario — cabina armadio L 310 H 257.7 P 60.4 con moduli a giorno in nobilitato bianco talco. Telai perimetrali, ripiani e cassettiere con frontali legno in nobilitato rovere scuro. Aste appendiabiti cromo.

Sipario — closet W 310 H 257.7 D 60.4 with smooth off-white open modules. Frames, shelves and drawer units with rovere scuro wooden fronts. Chrome hanging rods.

cabine armadio **SIPARIO_S06** 131

INFORMAZIONI TECNICHE

Technical information

Scegliere Pianca significa poter contare sulla qualità e sull'esperienza di una grande realtà italiana nel settore del mobile. La gamma dei prodotti, estremamente ampia ed in continua evoluzione, soddisfa ogni necessità d'arredo, nel segno della bellezza, della funzionalità, della durata e della trasversalità con gli altri ambienti della casa.

Choosing Pianca means relying on the quality and experience of a leading Italian company in the design furniture sector. Its vast range of continuously developing products meets all furnishing requirements, adding beauty, functionality, durability and versatility to all the rooms in the home.



Vista_ante Plana

Riferimento a pag. 32-35
Reference to page 32-35

Le ante Plana sono realizzate con pannelli lisci in particelle di legno Sp 2.5 cm, laccati opachi in 28 colori o pitturabili con tempere murali. La doppia maniglia U40 viene fissata sia all'interno che all'esterno del pannello per permettere l'apertura bifacciale.

Plana doors comprising plain wooden honeycomb-core panels 2.5 cm thick, available in 28 matt lacquered colours or paintable with tempera paint. The double U40 handle is fixed to the inside and outside of the panel for a bifacial opening.

Finiture Finishes

Anta:	laccato opaco, lucido spazzolato, pitturabile con tempere murali
Maniglia:	U40: brill, brunito, laccato opaco bianco, laccato opaco tortora
Binario:	alluminio anodizzato o pitturabile con tempere murali
Door:	<i>matt lacquered, high gloss brushed lacquered, paintable with tempera paint</i>
Handle:	<i>U40: brill, burnished, bianco matt lacquered, tortora matt lacquered</i>
Rail:	<i>anodized aluminium or paintable with tempera paint</i>

Modularità Modularity

Ante scorrevoli al centimetro
Made to measure sliding doors

L da 70 a 120 cm
W from 70 to 120 cm

H max 280 cm
H max 280 cm

Binario di scorrimento al centimetro

Made to measure rail

L max 600 cm
W max 600 cm



Vista_ante Crystal

Riferimento a pag. 44-47
Reference to page 44-47

Le ante Crystal sono disponibili con gola o con maniglia e sono realizzate con un vetro di 0.8 cm temperato senza alcun telaio perimetrale. La maniglia con gola è ricavata direttamente sul vetro, mentre una doppia maniglia U40 viene fissata sia all'interno che all'esterno del vetro per permettere l'apertura bifacciale.

The Crystal doors are available with groove or with handle are made with an 0.8 cm tempered glass panel without a perimetrical frame. The handle with groove is recessed directly into the glass while a double U40 handle is fixed to the inside and outside of the glass for a bifacial opening.

Finiture Finishes

Vetro:	trasparente, fumè, verniciato opaco, verniciato lucido
Maniglia:	gola verticale ricavata direttamente nel vetro U40: brill, brunito, laccato opaco bianco, laccato opaco tortora
Binario:	alluminio anodizzato o pitturabile con tempere murali
Glass:	<i>transparent, fumè, matt lacquered, glossy lacquered</i>
Handle:	<i>vertical groove incorporated in the glass U40: brill, burnished, bianco matt lacquered, tortora matt lacquered</i>
Rail:	<i>anodized aluminium or paintable with tempera paint</i>

Modularità Modularity

Ante scorrevoli al centimetro
Made to measure sliding doors

L da 70 a 120 cm
W from 70 to 120 cm

H max 280 cm
H max 280 cm

Binario di scorrimento al centimetro

Made to measure rail

L max 600 cm
W max 600 cm



Vista_ante Profilo

Riferimento a pag. 54-57; 64-67
Reference to page 54-57; 64-67

Le ante Profilo sono disponibili con gola o maniglia e sono realizzate con un vetro di 0.8 cm temperato rifinito con profilo perimetrale in alluminio. La maniglia con gola è ricavata direttamente sul vetro, mentre una doppia maniglia U40 viene fissata sia all'interno che all'esterno del vetro per permettere l'apertura bifacciale.

The Profilo doors are available with groove or with handle are made with an 0.8 cm tempered glass panel refined with aluminium perimetrical frame. The handle with groove is recessed directly into the glass while a double U40 handle is fixed to the inside and outside of the glass for a bifacial opening.

Finiture Finishes

Vetro:	trasparente, fumè, verniciato opaco, verniciato lucido
Profilo:	brill, brunito
Maniglia:	gola verticale ricavata direttamente nel vetro U40: brill, brunito, laccato opaco bianco, laccato opaco tortora
Binario:	alluminio anodizzato o pitturabile con tempere murali
Glass:	<i>transparent, fumè, matt lacquered, glossy lacquered</i>
Profile:	<i>brill, burnished</i>
Handle:	<i>vertical groove incorporated in the glass U40: brill, burnished, bianco matt lacquered, tortora matt lacquered</i>
Rail:	<i>anodized aluminium or paintable with tempera paint</i>

Modularità Modularity

Ante scorrevoli al centimetro
Made to measure sliding doors

L da 70 a 120 cm
W from 70 to 120 cm

H max 280 cm
H max 280 cm

Binario di scorrimento al centimetro

Made to measure rail

L max 600 cm
W max 600 cm

Libera & Snake

Finiture *Finishes*

- Schienali: laccato opaco in 28 colori o pitturabile con tempere murali
- Fianchi, ripiani e pedane: nobilitato bianco talco, nobilitato grigio texture, nobilitato rovere scuro, nobilitato noce canaletto, laccato opaco texture in 28 colori
- Cassettiere: la cabina Libera può essere abbinata a qualsiasi collezione di cassettiere (Anteprima, People, Segno, Norbert, etc.)
- Aste appendiabiti: titanio, bianco talco
- Snake: acciaio spazzolato
- Back panels: *matt lacquered in 28 colours or paintable with tempera paint*
- Side, shelves and platforms: *smooth off-white, grigio texture, rovere scuro, canaletto, matt lacquered texture in 28 colours*
- Drawer units: *the Libera closets can be matched with all drawer units (Anteprima, People, Segno, Norbert, etc.)*
- Hanging rods: *titanium, off-white*
- Snake: *brushed steel*

Modularità *Modularity*

Libera: Fianchi, ripiani e pedane al centimetro
 Libera: *Made-to-measure sides, shelves and platforms*

Snake: a passo 14 cm
 Snake: *14 cm step*

Schiene su misura fino ad una dimensione massima di cm L 115 H 300 Sp 2+1.2
Made-to-measure back panels (up to max cm W 115 H 300 Th 2+1.2.)

CABINE *closets*



Riferimento a pag. 119
 Reference to page 119
 L03

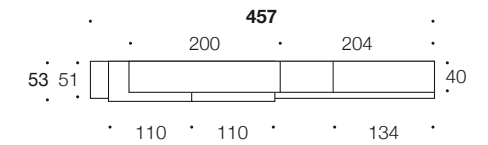

Riferimento a pag. 10
 Reference to page 10
 L01

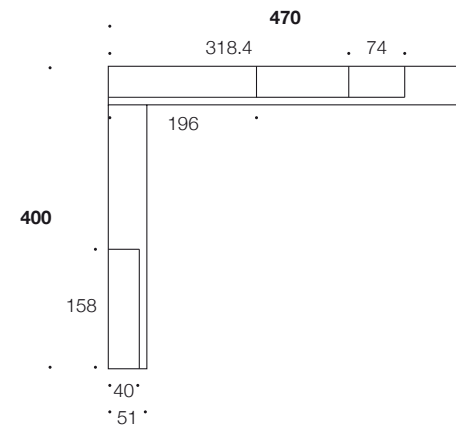

Riferimento a pag. 120
 Reference to page 120
 L04

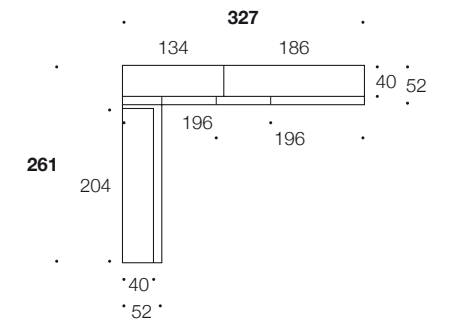

Riferimento a pag. 16
 Reference to page 16
 L02

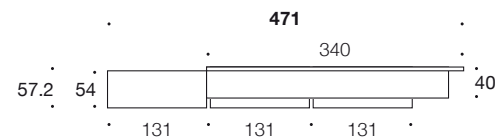

Riferimento a pag. 121
 Reference to page 121
 L05

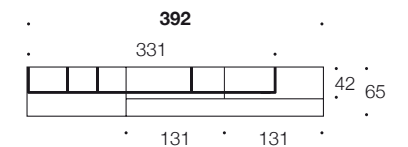

Anteprima

Finiture *Finishes*

Schienali: nobilitato bianco talco, nobilitato grigio texture, nobilitato rovere scuro, nobilitato noce canaletto, lac. opaco texture in 28 colori, specchio argento o fumè vetro opaco bianco retroilluminato

Ripiani e pedane: nobilitato bianco talco, nobilitato grigio texture, nobilitato rovere scuro, nobilitato noce canaletto, laccato opaco texture in 28 colori

Cassettiere e raster: nobilitato bianco talco, nobilitato grigio texture, nobilitato rovere scuro, nobilitato noce canaletto, laccato opaco texture in 28 colori

Frontali cassettiere: legno, vetro lucido

Aste appendiabiti e staffe: titanio, bianco talco

Back panels: smooth off-white, grigio texture, rovere scuro, canaletto, matt lacquered texture in 28 colours, silver or smoky glass mirror, back-lit bianco matt glass

Shelves and platforms: smooth off-white, grigio texture, rovere scuro, canaletto, matt lacquered texture in 28 colours

Drawer units and cubbies: smooth off-white, grigio texture, rovere scuro, canaletto, matt lacquered texture in 28 colours

Drawer unit fronts: wooden, glossy glass

Hanging rods: titanium, off-white

Modularità *Modularity*

Modulo: cm 50 / 70 / 90 / 110
Element: cm 50 / 70 / 90 / 110

Ripiani e pedane su misura fino ad una lunghezza massima di 3 metri
Made-to-measure shelves and platforms (up to max 3 metres wide)

Altezza *Height:*

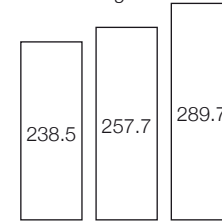

Riferimento a pag. 50
Reference to page 50
A02

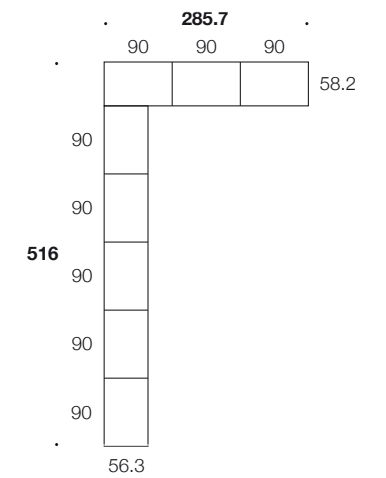

Riferimento a pag. 40
Reference to page 40
A01

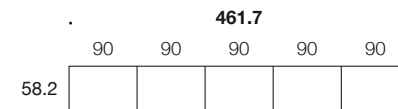

Riferimento a pag. 60
Reference to page 60
A03

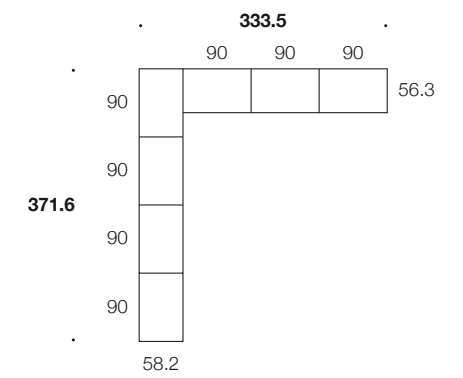

Riferimento a pag. 42
Reference to page 42

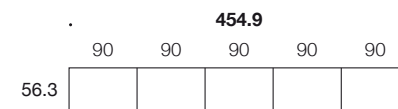

Riferimento a pag. 70
Reference to page 70
A04

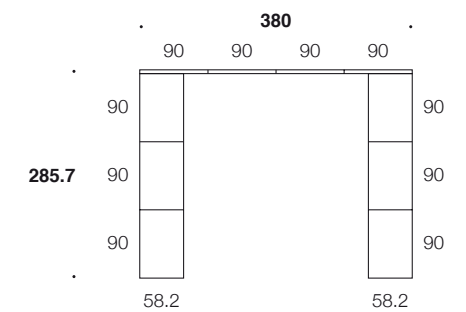

CABINE closets



Riferimento a pag. 123
Reference to page 123
A05

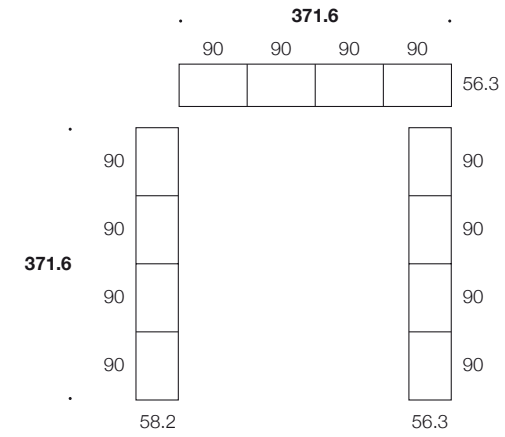

Riferimento a pag. 126
Reference to page 126
A08

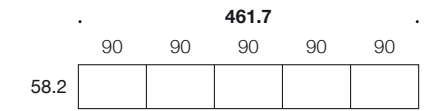

Riferimento a pag. 124
Reference to page 124
A06

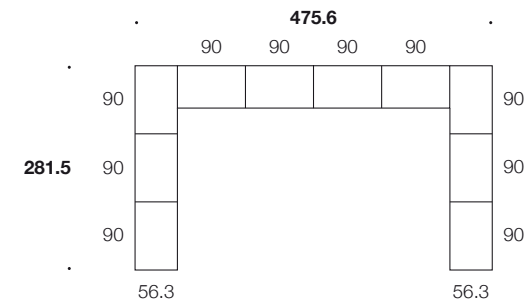

Riferimento a pag. 127
Reference to page 127
A09

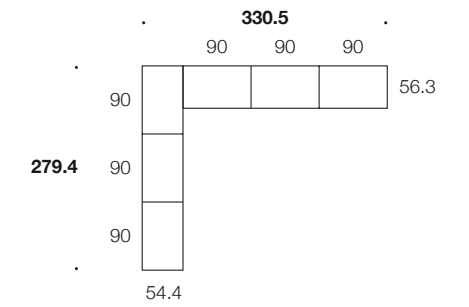

Riferimento a pag. 125
Reference to page 125
A07

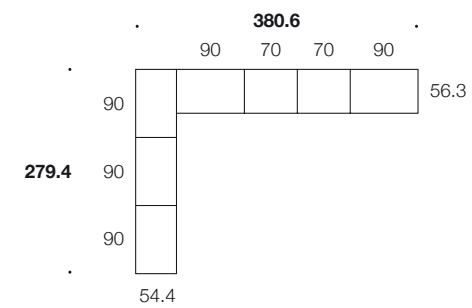

Sipario

Modularità *Modularity*

Modulo: cm 47.8 / 57.8 / 67.8 / 97.8 / 117.8 / 137.8 / 147.8
 Element: cm 47.8 / 57.8 / 67.8 / 97.8 / 117.8 / 137.8 / 147.8

Modulo angolo: cm 110.7 x 110.7
 Corner module: cm 110.7 x 110.7

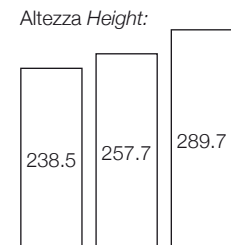

Finiture *Finishes*

- Scocca: nobilitato bianco talco, nobilitato grigio texture, nobilitato noce canaletto
- Telai perimetrali: nobilitato bianco talco, nobilitato grigio texture, nobilitato rovere scuro, nobilitato noce canaletto
- Cassettiere e ripiani: nobilitato bianco talco, nobilitato grigio texture, nobilitato rovere scuro, nobilitato noce canaletto, laccato opaco texture in 28 colori
- Aste appendiabiti: cromo satinato, bianco talco
- Structure: smooth off-white, grigio texture, canaletto
- Frames: smooth off-white, grigio texture, rovere scuro, canaletto
- Drawer units and shelves: smooth off-white, grigio texture, rovere scuro, canaletto, matt lacquered texture in 28 colours
- Hanging rods: chrome, off-white



Riferimento a pag. 90
 Reference to page 90
 S01

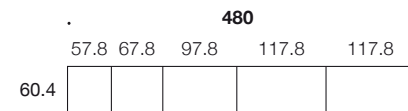

Riferimento a pag. 102
 Reference to page 102
 S03

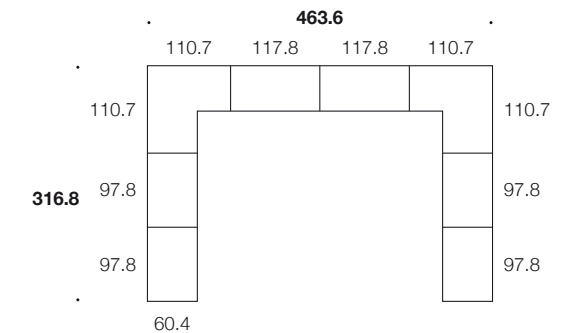

Riferimento a pag. 96
 Reference to page 96
 S02

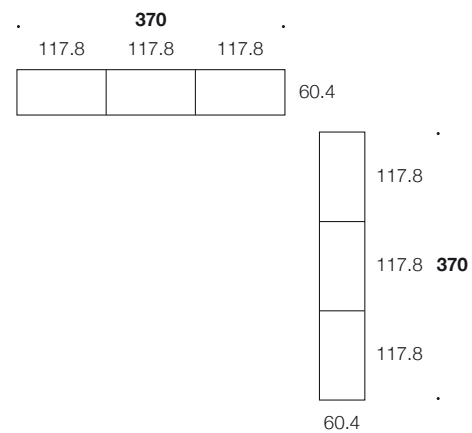



Riferimento a pag. 129
Reference to page 129
S04

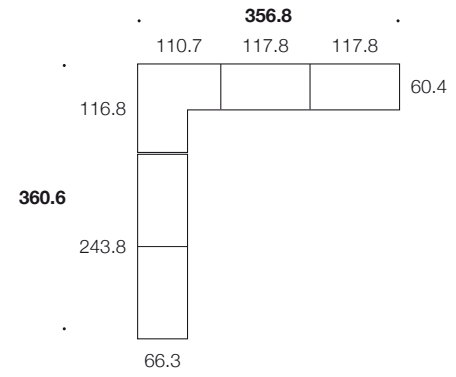

Riferimento a pag. 130
Reference to page 130
S05

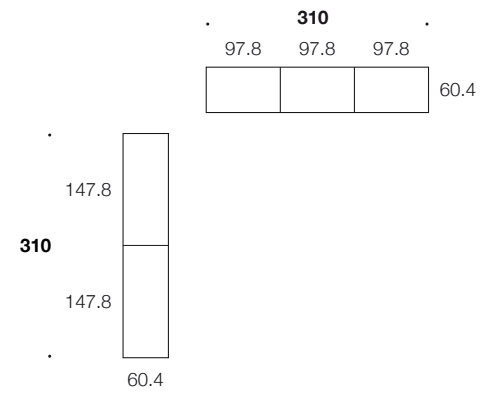

Riferimento a pag. 131
Reference to page 131
S06

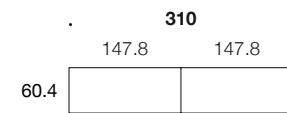

Photography
Beppe Brancato

Styling & Concept
Alessandro Pasinelli

Lithography
Grafiche Antiga

Printing
Grafiche Antiga

Credits
Spazio 900
Paloma Props
100fa
Co.Co
Galleria Luisa Delle Piane
Apres Paris (Tv)
Cast Srl (Pn)
Cereser (Pn)
Davide Lovatti
Studioarea22
Scenaperta

Printed in Italy

PIANCA
Via dei Cappellari, 20
31018 Gaiarine, TV Italy
Tel. +39 0434 756911
Fax +39 0434 75330
www.pianca.com
info@pianca.com